

## Building your own single transistor controller.

### *Why a single transistor?*

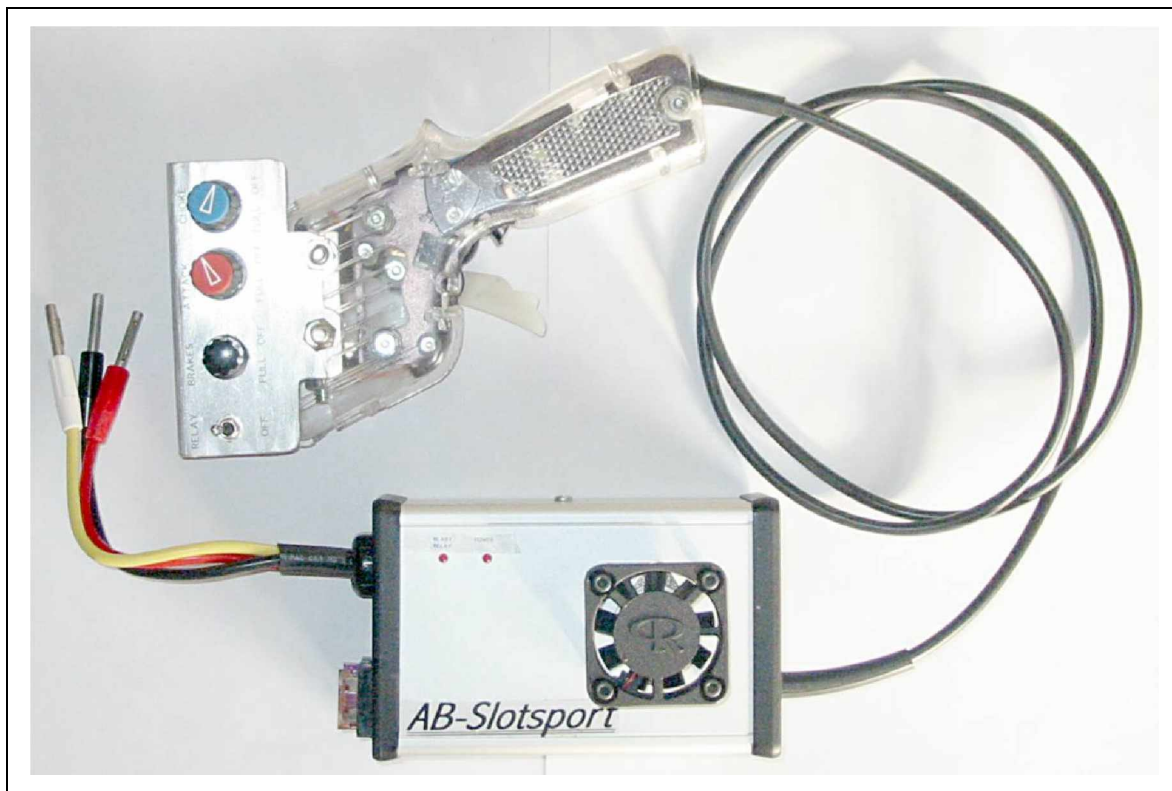

The vast majority of slot racers will use an electronic controller of one sort or another. The main reason for this is that an electronic controller will allow you to adjust its' characteristics to suit the car you are driving.

Most British built controllers use a variation on the circuit outlined by Chris Frost in his article on the BSCRA web site. These controllers usually have two transistors connected as a "Darlington Pair". This means that the transistor that handles the power to the car is effectively controlled by the other transistor. This combination works very well but has one major drawback; the difference between full power and just below full power is at least 1.2 volts. Consequently, a quick corner on a raceway style track may well be too tight to take flat out, but the next step down on the controller doesn't give enough power.

To combat this problem of too large a bottom step, it is possible to use a single transistor. With a single transistor, the bottom step is reduced to a minimum of 0.6 volts. Controllers such as the Pro 2 use a single NPN transistor. The problem with this type of set up is that the power flow through the transistor is backwards compared to the PNP transistor used in British circuits and you have to have a separate set of brake and full power contacts

to turn off the transistor when braking or applying full power. NPN transistors were used because it wasn't always easy to get hold of PNP types that were capable of handling the large currents that may flow in the event of a short on the track. After a little searching on the Internet, I've found a suitable transistor, A PNP transistor with a type number of MJ14003. This transistor is capable of handling a constant 60 amps – more than enough if you fit a 30-amp fuse as circuit protection.

The circuit used is almost identical to the conventional British circuit, except that the Darlington pair is replaced with a single MJ14003. The values of the resistors in the resistor chain and the potentiometers that control sensitivity and choke are also changed to lower values than you would use in a standard British set up. The values are reduced to enable the controller to be more stable when the transistor heats up.

The list of parts covers the basic components needed, additional parts for tweaks like the fuse block, blast relay switch etc are detailed on the AB Web page. For convenience, some parts are available from AB Slotsport as sub-assembly kits, to save you the time of finding them yourself, or if you have problems sourcing them if you are outside the UK. You will see that the cost of the basic parts for this controller is less than £100. For the most simple build, the Parma Turbo frame is a better bet as a base as it already has an independent "full power" contact that may be utilised for the blast relay and it's also easier to bolt on the bracket to the frame.

The build time (assuming you have reasonable soldering skills and some basic hand tools) is between 3-5 hours. If you are willing to spend some time and care doing the build, you will have a top of the range controller for a very attractive price and worth well in excess of twice the price of the parts.

**You will see the brake system on the project is Diode type, this was to keep the cost down, but nothing to say you can't go the Parma/Koford resistor type instead, just more expensive.**

**The thing about diode brakes is that it gives "roll on brakes" as it works on voltage drop, not resistance, so dependant on how many diodes you dial in, you initially get full brakes and then as the car slows and the EMF drops the car rolls dependant on the blocking voltage (typically around 0.6volt per diode).**

## What you need

Part Number	Description	Price	Qty	Cost	Supplier
7429282	20v Diodes 1N5817	£0.15	8	£1.20	Farnell in One
149680	M3 Nuts 100 Pack	£1.04	1	£1.04	Farnell in One
149506	M3x10 P Slotted Machine Screws 100 pack	£0.99	1	£0.99	Farnell in One
149508	M3x16 P Slotted Machine Screws 100 pack	£0.99	1	£0.99	Farnell in One
149505	M3x6 P Slotted Machine Screws 100 pack	£0.99	1	£0.99	Farnell in One
770292	Miniature Resistor 2R	£0.01	100	£1.20	Farnell in One
3060354	Miniature Resistor 3R3	£0.05	50	£2.50	Farnell in One
2332012	MJ14003 PNP Bipolar Transistor	£10.00	1	£10.00	Farnell in One
350849	Potentiometer 10R	£4.83	2	£9.66	Farnell in One
422460	Rotary Switch 12 position	£0.99	1	£0.99	Farnell in One
LJ68Y	40Amp 12V Auto Relay	£1.49	1	£1.49	Maplins
RG08J	40mm 12 sleeve fan	£7.99	1	£7.99	Maplins
JU25C	40mm Fan Guard	£0.99	1	£0.99	Maplins
N76AL	Aluminium Box	£6.99	1	£6.99	Maplins
DR81C	Blade Fuse 35Amp and 10 Amp	£0.19	2	£0.38	Maplins
QY00A	LC Button Cap Black	£0.19	1	£0.19	Maplins
QY01B	LC Button Cap Blue	£0.19	1	£0.19	Maplins
QY04E	LC Button Cap Red	£0.19	1	£0.19	Maplins
YG40T	Low-Cost Collet Knob	£0.49	3	£1.47	Maplins
QT85G	Threaded spacer	£1.29	1	£1.29	Maplins
M30R	Miniature Resistor 30R	£0.07	1	£0.07	Maplins
	Parma 35 Ohm HO Plus resistor	£9.85	1	£9.85	SCD
	Red Fox Controller Handle	£18.95	1	£18.95	AB Slotsport
				£79.60	
				£79.60	
Total Farnell	<a href="http://www.farnellinone.co.uk/">http://www.farnellinone.co.uk/</a>			£29.56	
Total Maplins	<a href="http://www.maplin.co.uk/">http://www.maplin.co.uk/</a>			£21.24	
Total SCD	<a href="http://www.scdparma.fsnet.co.uk/">http://www.scdparma.fsnet.co.uk/</a>			£9.85	
Total AB Slotsport	<a href="http://www.abslotsport.biz">http://www.abslotsport.biz</a>			£18.95	
Total Cost				£79.60	





the manufacturing tolerances in the individual resistors. If you have used a conventional board, it should look similar to the picture below.

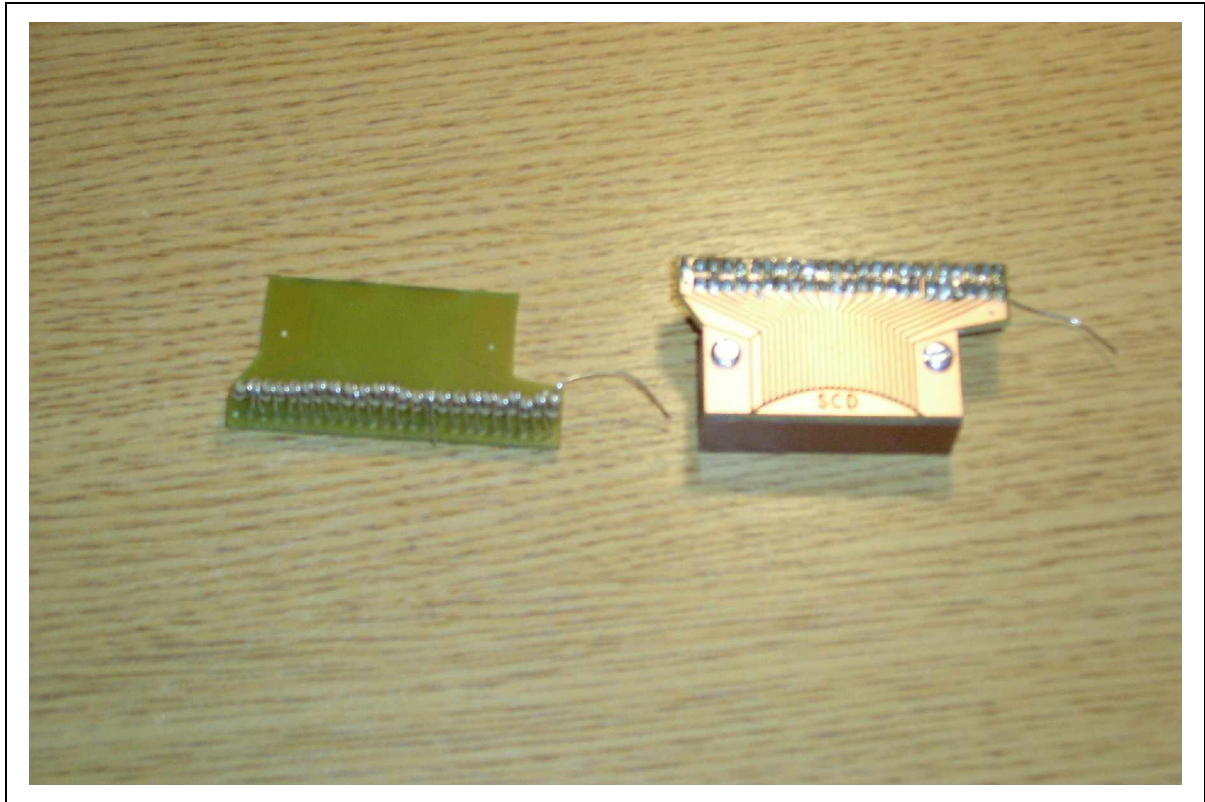

### **Assembling the Diode Brake Selector.**

First bend the selector switch contacts as shown in the picture and remove contacts 10, 11 and 12.

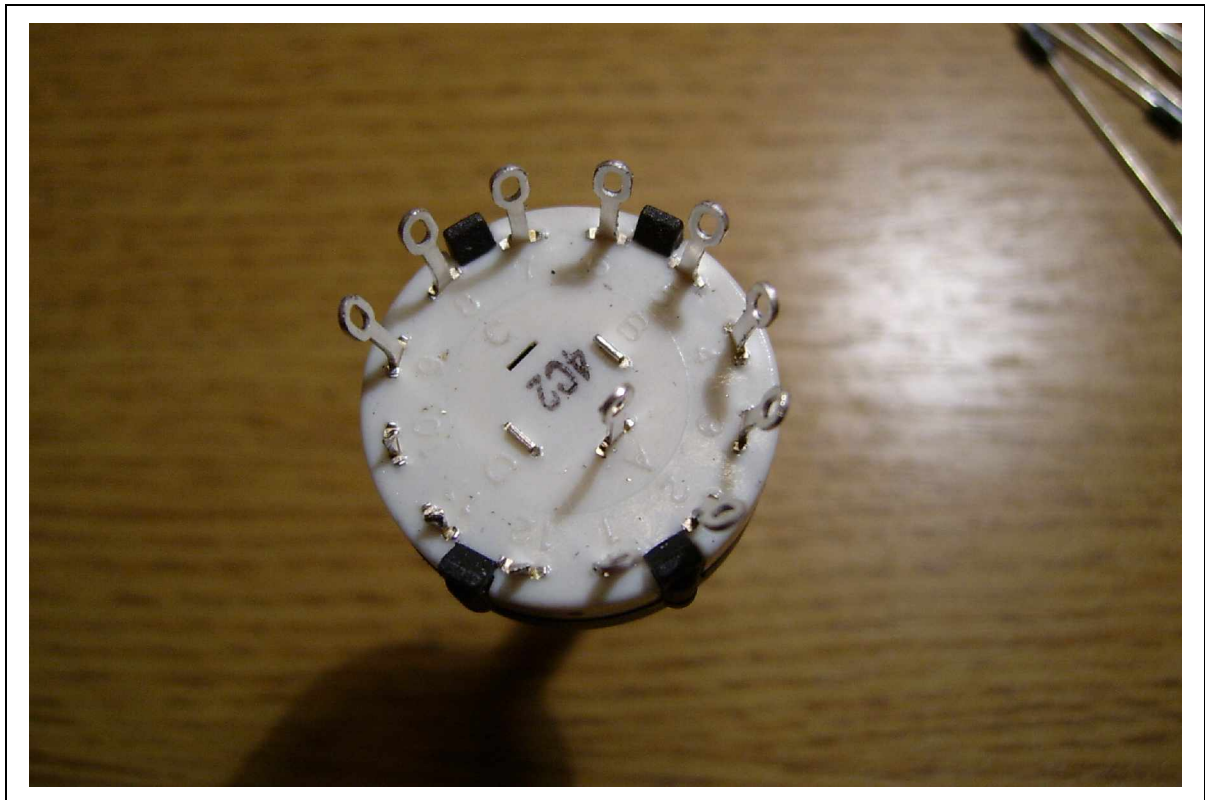

Using the supplied tagged washer set the switch so that you can select any of the contacts 1 to 9 but not 10, 11 and 12. Attach the red wire coming from the brake contact on the controller handle to position 1, and a black wire to the central common contact. The other end of the black wire will go through the handle into the transistor/relay box to the 10-amp brake circuit protection fuse. Between each pair of contacts 1 & 2, 2 & 3, 3 & 4, 4 & 5, 5 & 6, 6 & 7, 7 & 8 and 8 & 9, connect your diodes. Each diode should have the silver band at the left hand end (or anti clockwise end) when you view the switch from the contact side with the diode you are looking at in the 12 o'clock position. If you need any further guidance about building this assembly, check out the AB Slot sport web site at [www.abslotsport.biz](http://www.abslotsport.biz). The finished brake unit should look similar to the picture below.

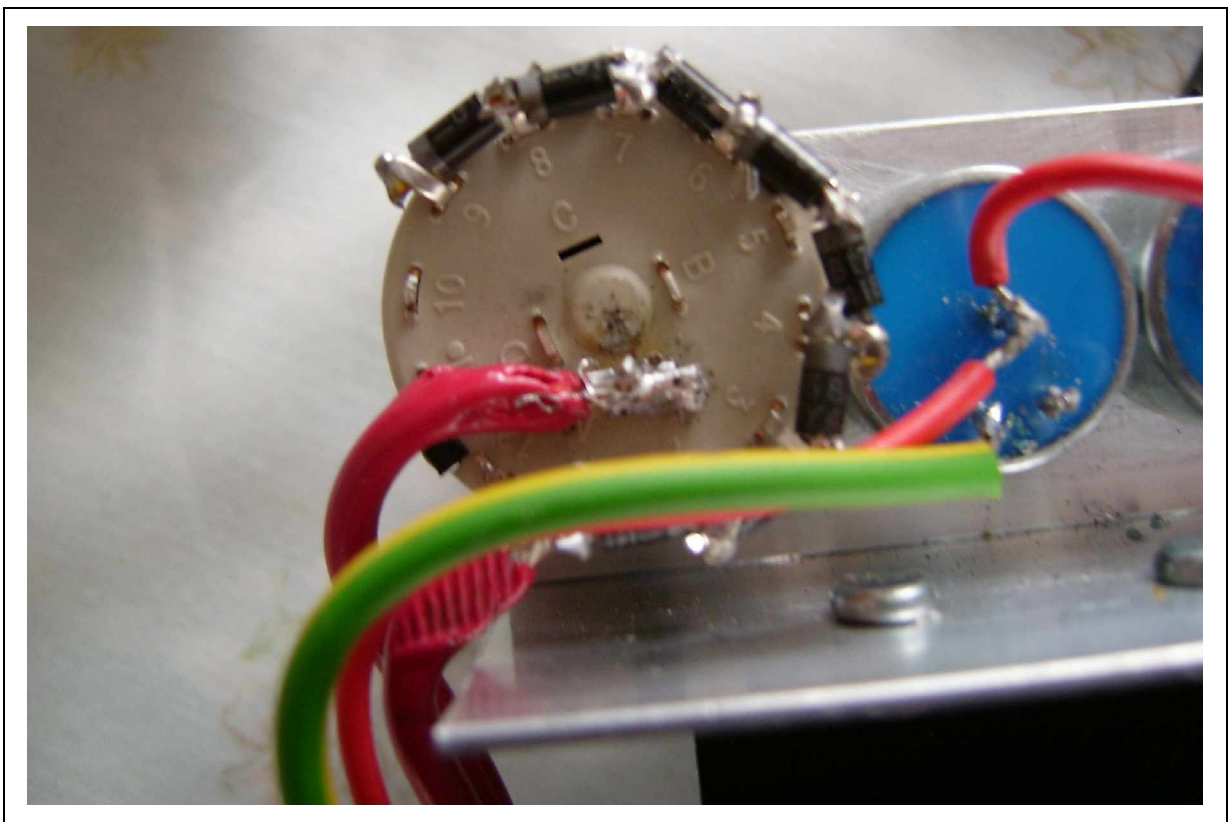

## Assembling the Adjustment Unit

Next you need to mount the sensitivity pot, the choke pot and the diode brake kit onto the vertical side of a piece of aluminium angle (I got mine from B&Q). I've attached mine in the following order from left to right as you look at the control knobs, Choke, Sensitivity and Brake. This ensures that I can easily find the choke control during a race without having to take my eyes off the track. This angle needs to be bolted onto the top of the resistor guard on your Parma Turbo handle or onto two 90-degree brackets on the side of the Red Fox unit. You can make the brackets from the same aluminium angle. Make sure that you smooth any sharp corners off the angle. Attach any wires you need onto the pots and switches at this stage, and make sure that you know which wire goes where! The finished adjustment unit should look like the picture below.

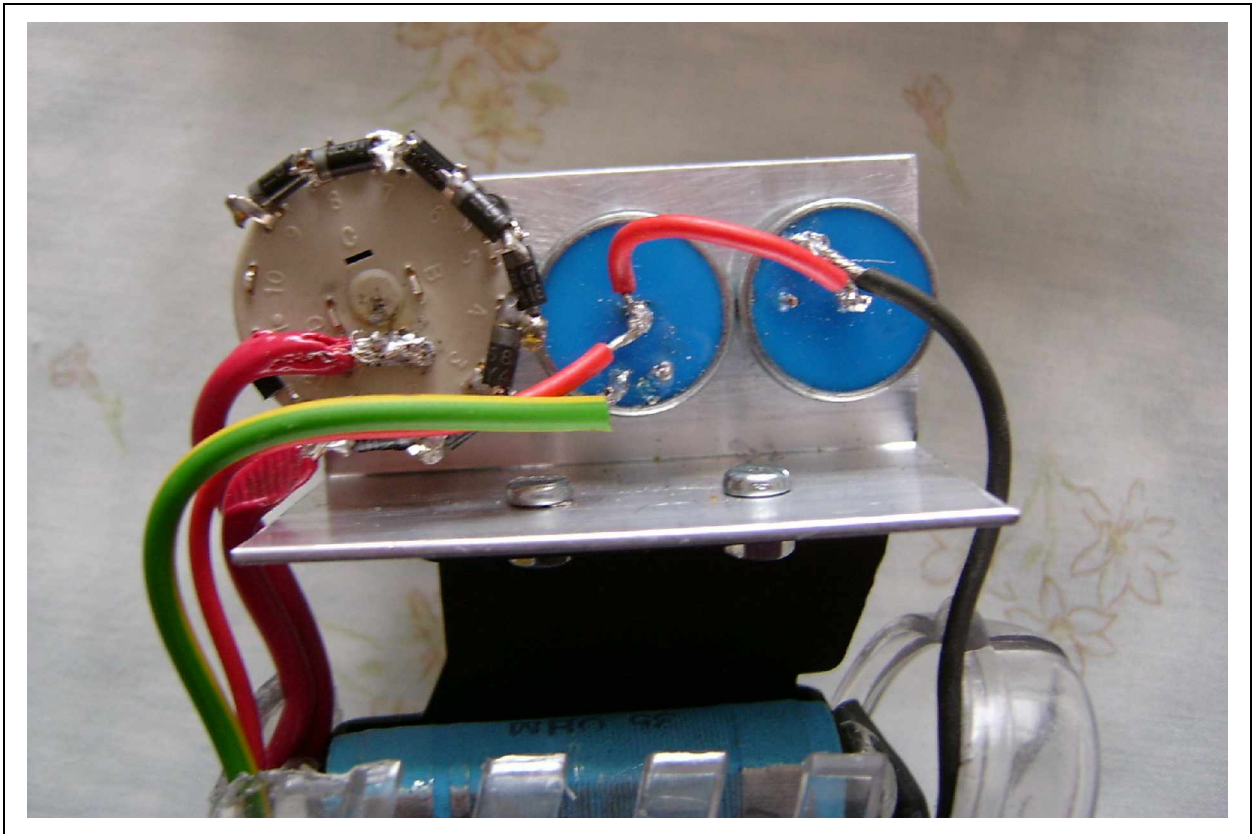

Alternative Mounting system for Resistor Pot, Brake and optional Blast Relay switch; The following is a template to make your bracket from 16g aluminium sheet.

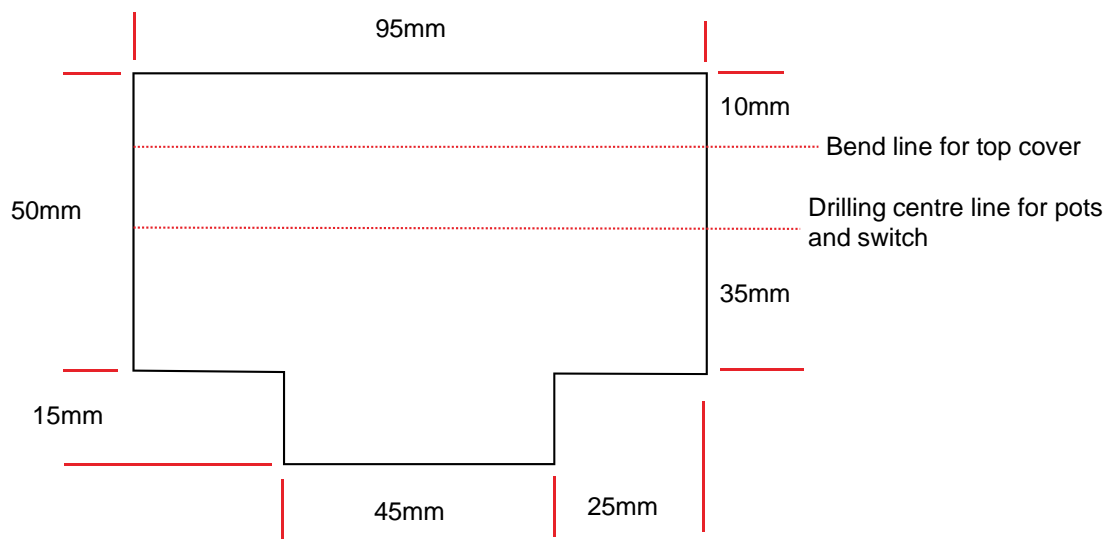

The bracket may be bolted to the rear of the controller frame. For racers racing on scale track, the blast relay switch option is a good idea, so you can switch out the blast relay to “quieten” frisky cars on tight tracks.



## Assembling the Transistor and Relay Box.

There are no setting controls on the box. The box houses the transistor and fan mounted on the outside and the fuses and relay inside. The transistor is mounted on the outside of the box with the base and emitter pins going through to the inside of the box (ensure to drill the holes oversize to clear the pins on the transistor to ensure no “shorts”. The connections to the transistor, fuses, fan and relay are all made inside the box. Next, take the fan protection grille and use it as a template to mark out where the fan mounting screws will be fitted. You should drill holes for the fan mounting screws, transistor terminals & screws and a small hole for the fan wires to pass through inside the box. You should also drill holes in the box endplates for the cables to the handle and the plug at this point. Should you wish to fit indicator LEDs for Power and blast relay function drill these.



The fan should sit directly over the transistor as shown in the picture. You will need to seat the fan on 4 small threaded spacers in order for the fan blades to clear the top of the transistor.

Use proper cable glands to introduce main cables (to track and controller) into the box and use cable ties behind the glands to act as “stress relief” and prevent cables from “pulling through”

Wiring Tip;- When connecting multiple cable to one point (fuse block etc.) Strip cables, wind stripped portions together and put a piece of shrink wrap around the end of the insulated portions to bind cables together before you tin with solder.



It can be an idea to fit the fuses as a “block” through the end cover plate. This makes the fuses accessible and also acts as a “terminal block for soldering wires inside the box.

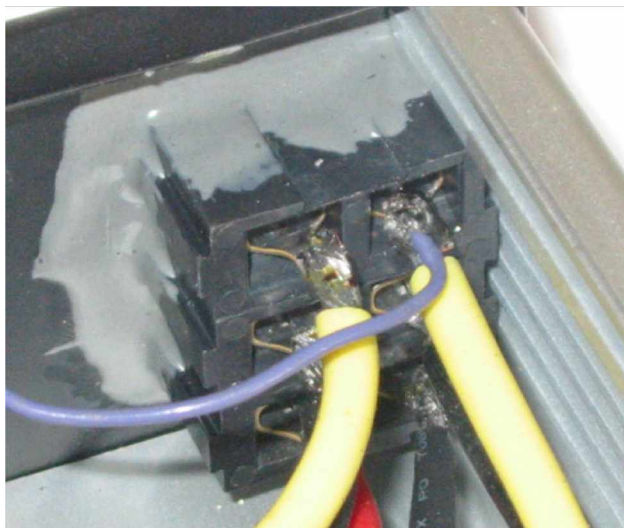

Locate the fuse holder in the corner of the box, mark around it on the inside of the endplate with a scribe and then cut out the endplate carefully with a Dremmel. Glue the Fuse block into the endplate with JB Weld or Epoxy of your choice.

If fitting indicator LEDs these can be glued into the box with epoxy from the inside (just cover the back of the led and surrounding area with epoxy and embed). To connect the LEDs, common the short legs and connect to BRAKE line, connect the Blast relay LED positive leg to the wire from the Blast Relay Switch ( or full power contact if switch not fitted). Connect positive leg of Power LED to incoming power lead.

## Final Assembly

Assemble the controller handle, resistor or board and adjustment unit. Wire all the parts together using the wiring diagram below as a guide. Note that there are 5 wires coming from the controller handle. 1 from the brake band, 1 from the choke pot, 1 from the sensitivity pot, 1 from the full power contact and 1 from the wiper. It is possible to use a good quality 6 core cable between the handle and box (RS number 482-6014) This is also available from AB Slotsport in 1 mtr. lengths.

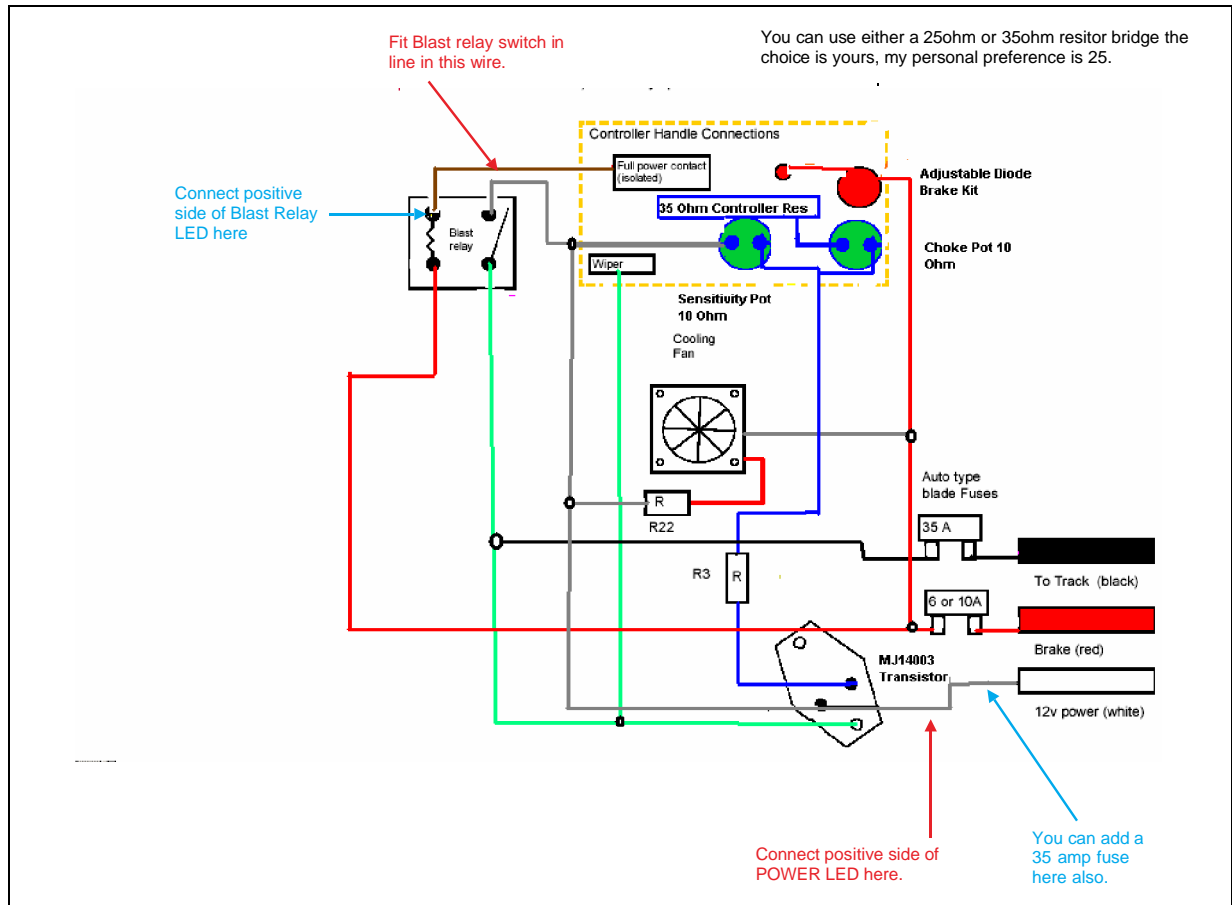

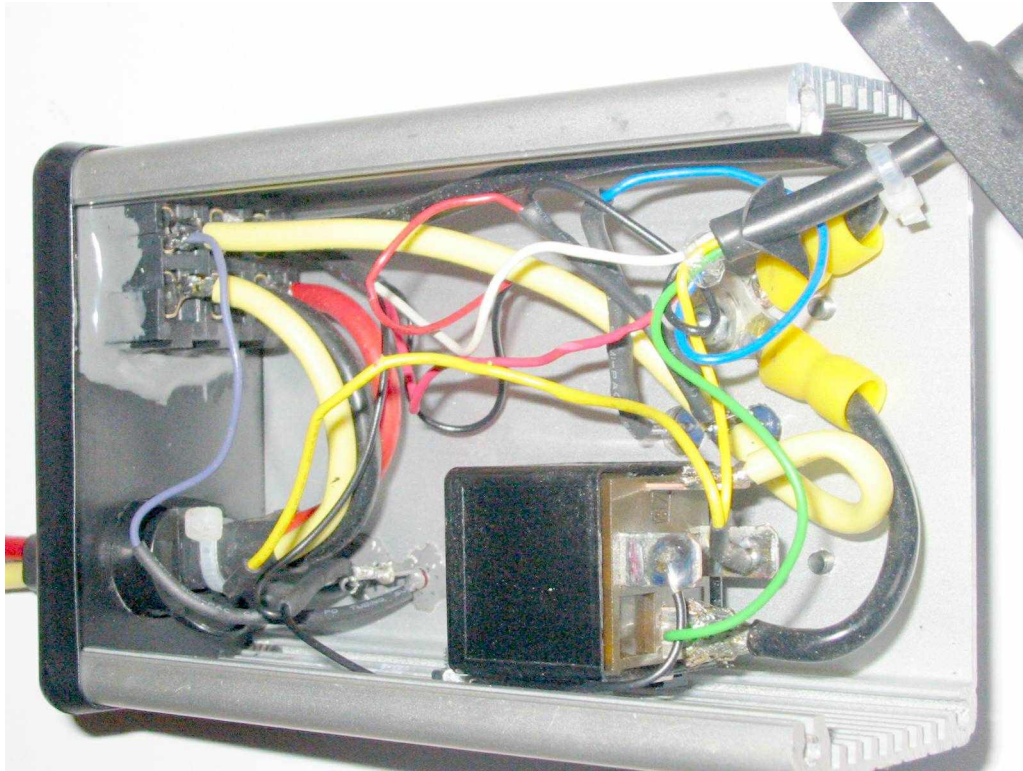

The “Hammond” box is really ideal for this application as you can build and wire all components in the box and then use the slide lid as the “base” and closure. From experience with these boxes, care should be taken when screwing on the endplates to ensure the self tapping screws follow the original thread the screw has cut into the aluminium extrusion. Repeated unscrewing / refitting can tend to strip the aluminium and make the screws a loose fit.

Above you can see the layout of the interior of the box. Note the blast relay bolted to the side of the box and the way in which the fuse block is also used as a “main terminal block” for many of the connections, making layout and assembly less messy and tidier. Note cable ties behind the cable glands, this helps to prevent cables being “yanked out of the box” in moments of “stress” during racing.

Not having anything better to do with my life, the transistor and fan holes in the box are drilled and tapped 3mm so there is no need to use nuts on the bolts during assembly. A 3mm tap and drill can be purchased through your local tool outlet for around £5 – 8.

Your controller is now ready for testing.

Many thanks to Paul Bucknell and Chris Frost for all their help with the project.

For your convenience, many components for this controller are stock at AB Slotsport, check <http://www.abslotsport.com/page64.html> for details.



